



Parker Hannifin Corporation
Porter Instrument
245 Township Line Road
Hatfield, PA 19440
Office 215-723-4000

Nitronox[®] Scavenger Plus

Instructions for Use



Representation

	Legal Manufacturer	Parker Hannifin Corporation Precision Fluidics Division Porter Instrument 245 Township Line Road Hatfield, PA 19440 Office: (215) 723-4000 Fax: (215) 723-5106
---	---------------------------	--

READ MANUAL COMPLETELY BEFORE OPERATING THIS DEVICE

This document contains warnings, cautions, instructions for use, and maintenance information that the user must completely comprehend before using this device. Failure to properly operate and maintain this device may result in patient and/or user harm and/or damage to equipment.

Table of Contents

1. Device Information.....	4
1.1. Intended Use	4
1.2. User Interface.....	4
1.3. General Description/Principles of Operation	4
1.4. Use of the Device	5
1.5. Warnings & Cautions	5
1.6. Safety Features	5
1.7. Specifications	6
2. Installation Instructions	7
2.1. Installing the Nitronox Scavenger Plus	7
2.2. Connecting Vacuum Line and Reservoir Bag	8
3. Instructions for Use.....	9
3.1. Setup and Pre-Use Checks.....	9
3.2. Scavenging.....	10
4. Maintenance	11
4.1. Pre-Check	11
4.2. Cleaning the Device	12
5. Symbols Glossary	13
6. Warranty	15



WARNING: This product can expose you to chemicals, including lead and formaldehyde, which are known to the State of California to cause cancer, birth defects, or other reproductive harm. For more information, go to www.P65Warnings.ca.gov.



CAUTION: Federal law restricts this device to sale by or on the order of a physician or dentist.



Visit our website: <http://www.porterinstrument.com/medical> for additional information.



To download Instructions for Use: www.porterinstrument.com/medical-support Choose Scavenging System from the dropdown within the “Product Download” section.

1. Device Information

1.1. Intended Use

The Nitronox Scavenger Plus is intended to control the vacuum flowrate for scavenging of waste analgesic gas.

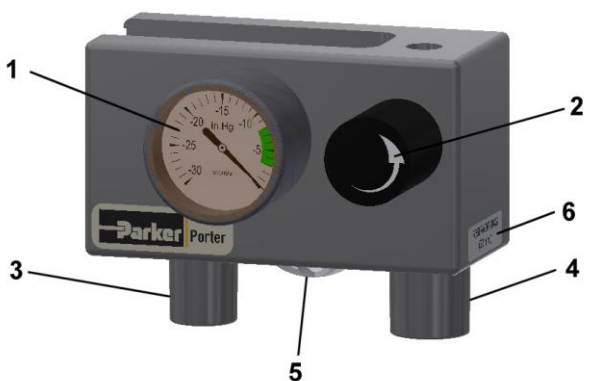
1.2. User Interface

#	Description	Image
1	Operating Pressure Gauge	
2	Flow Control Knob	
3	Inlet (Patient) Port	
4	Reservoir Bag Port	
5	Under-Pressure Valve	
6	Label, Reservoir Bag	
7	Mounting Lock Screw	
8	Over-Pressure Valve	
9	Vacuum Source Connection	
10	Label, Vacuum Supply	
11	Label, Device	
12	Label, Medical Breathing Circuit	

1.3. General Description/Principles of Operation

The Nitronox® Scavenger Plus device is a vacuum interface designed to be use with a nitrous oxide/oxygen conscious sedation system to allow removal of waste analgesic gases through a vacuum source. The Scavenger Plus functions by utilizing a vacuum source and a vacuum flow control knob to adjust the vacuum flow rate. A reservoir bag allows transient storage of waste gas from large exhalations, and a combination of under and over-pressure valves ensures no fresh gas is siphoned from the patient while preventing over-pressurization.

The Nitronox Scavenger Plus is equipped with safety features, which are described in Section 1.6.

1.4. Use of the Device

The Nitronox Scavenger Plus is intended to be used by medical professionals trained in the use and administration of nitrous oxide (N₂O) and oxygen (O₂) gases. The device is designed for use in a gas delivery and scavenging system for pain management and / or minimal conscious sedation, which is ideal for short, minimally invasive procedures to alleviate patient anxiety or minor pain and discomfort. It is the responsibility of the medical professional to consider the side effects, contraindications, and risks associated with administration of N₂O and use of conscious sedation.

The Nitronox Scavenger Plus is not used as part of, or in conjunction with, a general anesthesia administration system. This device should only be used to scavenge N₂O and O₂ medical gases.



WARNING: Do not use this device for the administration of general anesthesia or as part of, or in conjunction with, a general anesthesia administration system.

1.5. Warnings & Cautions

Warnings and cautions are listed where relevant to a certain section of this manual. A **WARNING** is an instruction, procedure, or explanation of hazards that may result in personal injury or death. A **CAUTION** is an instruction, procedure, or explanation of hazards that may result in damage to a product, equipment, or the environment.



WARNINGS and **CAUTIONS** are presented throughout the document along with this symbol to alert the reader of their presence.

1.6. Safety Features

Under Pressure Valve

The Nitronox Scavenger Plus contains a safety mechanism that prevents under pressure (i.e., over scavenging). When the pressure becomes too low, a valve will open to allow room air into the Nitronox Scavenger Plus to prevent gas from being over scavenged from the patient. This may occur during normal use between patient breaths as the reservoir bag becomes empty.

Over Pressure Valve

The Nitronox Scavenger Plus also contains a safety mechanism that prevents over pressure. If the pressure in the Nitronox Scavenger Plus becomes too high, a valve will open to release pressure into the atmosphere. This should not occur during normal use. The over pressure valve will become open when the reservoir bag appears full. This indicates that either the Nitronox Scavenger Plus is not set properly to supply adequate vacuum flow, the vacuum source is not supplying adequate vacuum flow, or there is some other fault condition in the system.



WARNING: An O₂ enriched environment can accelerate the spread of ignited materials. Therefore, when the Nitronox Scavenger Plus and a conscious sedation system are used in conjunction with energy producing devices (such as lasers, RF sources, or other heat sources) the user must adhere to the instructions for use of those devices to avoid ignition of combustible materials.



WARNING: The Nitronox Scavenger Plus is not intended or expected to be used during an MR exam and has not been evaluated for safety and compatibility in the MR environment. The safety of the Nitronox Scavenger Plus in the MR environment is unknown, but due to the presence of materials in the device that may be ferromagnetic, the Nitronox Scavenger Plus should be considered “MR Unsafe” and should be kept outside of any MRI scanner rooms.

1.7. Specifications

Dimensions

4.3 in L x 4.3 in W x 3.5 in H
(10.8 cm L x 11.0 cm W x 8.1 cm H)

Vacuum Source Characteristics

Pressure Range: 10-21 inHg (33.8-71.1 kPa)
Flow rate: 50 L/min minimum

Connection Fittings

Vacuum Supply: 3/8 in barb
Breathing Circuit: 19 mm taper (male)

Environmental

Temperature

Storage/Transport: -40°F-140°F (-40°C-60°C)
Operational: 40°F-100°F (4°C-38°C)

Relative Humidity

Storage/Transport: ambient, non-condensing
Operational: ambient, non-condensing

Weight

1 lb (0.45 kg)

Operating Characteristics

Pressure Range: 3-8 inHg (10.2-27.1 kPa)

Breathing Bag

Volume: 2 L minimum

Atmospheric Pressure

1 atm \pm 0.2 atm (101 kPa \pm 20 kPa)

2. Installation Instructions

2.1. Installing the Nitronox Scavenger Plus

Note: If a Nitronox Scavenger Plus is to be used with a N₂O and O₂ conscious sedation delivery system, the Scavenger Plus should be installed before mounting the device.

Note: The Nitronox Scavenger Plus is compatible with the Nitronox Plus system. (NOX-part series). The Nitronox Scavenger Plus is also compatible with other devices that feature a 19mm taper.

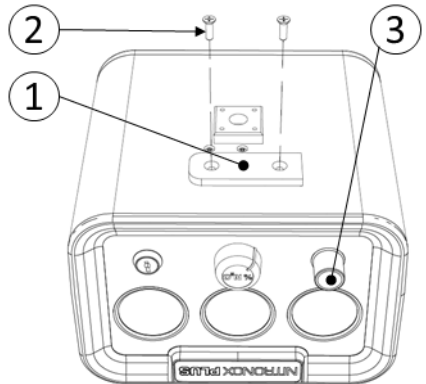
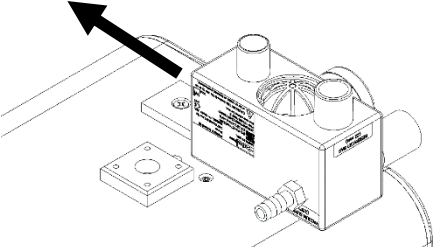
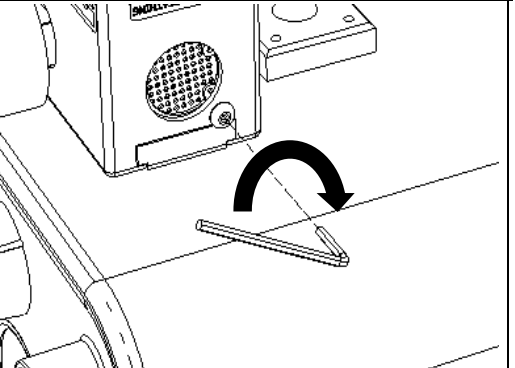
1	Align the Scavenger Bracket (1) so the end with square corners is facing the side of the Nitronox Plus with the Connection Port (3). Install the bracket using the provided screws (2).	
2	Slide the Nitronox Scavenger plus onto the bracket as shown. Ensure the gauge and dial face the front of the device.	
3	Tighten the set screw on the Nitronox Scavenger Plus using a 3/32 inch Hex Key.	

2.2. Connecting Vacuum Line and Reservoir Bag

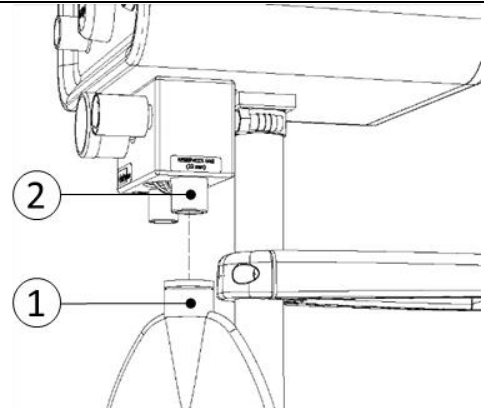
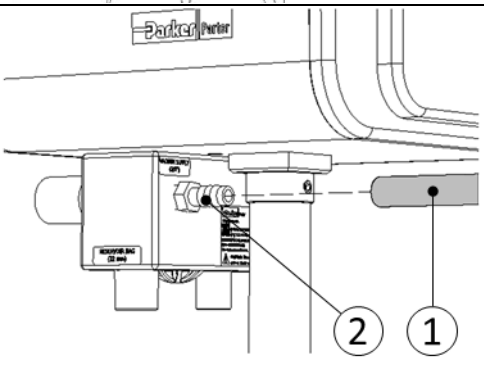
1	Attach Reservoir Bag (1) to the Nitronox Scavenger Plus Reservoir Bag Port (2) .	
2	Attach the vacuum source hose (1) to the barb fitting on the back of the Nitronox Scavenger Plus (2) .	

3. Instructions for Use

3.1. Setup and Pre-Use Checks

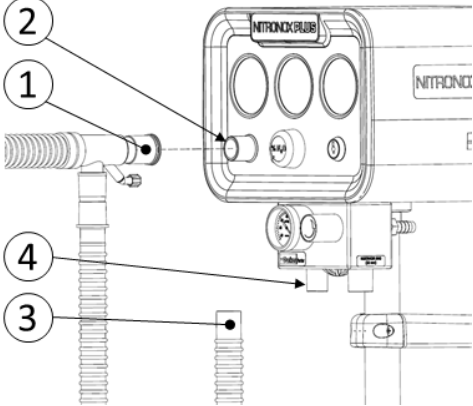
1	Ensure the Nitronox Scavenger Plus is adequately mounted in conjunction with the conscious sedation system.
2	Ensure the necessary pre-checks have been performed, before using the Nitronox Scavenger Plus. The pre-check instructions are described in Section 4.1 Pre-Checks .
3	<p>Connect the Medical Breathing Circuit (1) to the appropriate port of the conscious sedation system (2). Connect the scavenging hose (3) to the scavenger port on the Nitronox Scavenger Plus (4).</p>  <p>The diagram illustrates the connection of a medical breathing circuit (1) to a conscious sedation system (2). It also shows a scavenging hose (3) connected to the scavenger port on the Nitronox Scavenger Plus (4). The device is labeled 'NITRONOX PLUS' and 'NITRONOX'.</p>
4	Ensure all connections are tight and secure.

3.2. Scavenging



WARNING: Workers exposed to excess N₂O may suffer harmful effects. The healthcare professional is responsible for employing proper techniques, such as scavenging, room ventilation, system maintenance, and patient compliance to reduce exposure (ACGIH recommends a Threshold Limit Value of 50 parts per million over an 8-hour time-weighted average).

1	<p>Before initiating administration of analgesic gas, slowly turn the flow control knob (1) on Nitronox Scavenger Plus counterclockwise until the pressure displayed on the vacuum gauge (2) is within the green band (-3 to -8 inHg).</p>	
2	<p>Begin administering analgesic gas in accordance with the mixing device's instructions for use.</p>	
3	<p>Once the procedure begins, the reservoir bag may slightly inflate upon patient exhalation. Monitor the reservoir bag to ensure the reservoir bag goes from deflated (1) to slightly inflated (2) when the patient exhales, then deflates again before the next exhalation.</p> <p>The pressure displayed on the Nitronox Scavenger Plus should be maintained at the lowest setting that allows complete deflation of the bag between patient breaths. If the reservoir bag begins to accumulate gas, increase the vacuum flow by adjusting the flow control knob.</p>	

Note: If the reservoir bag continues to fill even after completely opening the flow control knob, check that the vacuum supply is ON, there is an adequate vacuum source pressure (10 to 21 inHg), the device is set to the correct vacuum pressure (3 to 8 inHg), the vacuum hose is properly connected, and there are no kinks in the vacuum hose. If gas continues to accumulate, contact your authorized representative for troubleshooting.



WARNING: Operation of the device outside of the green band may not provide adequate scavenging. Operation under these conditions requires monitoring of the reservoir bag. If the reservoir bag does not deflate after exhalation, and the vacuum gauge is below the green band, use of N₂O should be discontinued.

4. Maintenance

The Nitronox Scavenger Plus has an expected lifetime of 5 years and does not require periodic maintenance or service.



WARNING: Proper inspection and maintenance of this device is essential to prevent gas leaks. All hoses, fittings, and connections should be inspected regularly, and all leaks should be repaired immediately.



CAUTION: Do not attempt to repair, calibrate, or alter this device. Unauthorized repair, calibration, alteration, or misuse of the device is likely to adversely affect performance and will void the warranty.

4.1. Pre-Check

To perform the following tests, a compatible breathing circuit, reservoir bag, and proper connection to the vacuum supply are required.



WARNING: If precheck test cannot be executed successfully, do not use this device and contact distributor.

Leak Test

1	Ensure the vacuum is turned off (turning the flow control knob clockwise until tight or shut off vacuum source)
2	Using the breathing circuit, exhale into the reservoir bag until full
3	Monitor the time it takes for the reservoir bag to completely deflate
4	If the reservoir bag completely deflates within 30 seconds, contact your authorized distributor for service and troubleshooting

Under-Pressure Valve Open Test

1	Ensure the vacuum is turned on
2	Adjust to maximum vacuum (turning the flow control knob counterclockwise, recommended setting between 3 - 8 inHg)
3	Create a seal by placing your hand over the inlet (patient) port
4	If you feel vacuum (suction on your hand and/or gauge changes), contact your authorized distributor for service and troubleshooting

Over-Pressure Valve Open Test

1	Ensure the vacuum is turned off (turning the flow control knob clockwise until tight or shut off vacuum source)
2	Using the breathing circuit, exhale into the Nitronox Scavenger Plus device until the reservoir bag is fully inflated
3	Continue to exhale into the breathing circuit
4	If you feel resistance to exhalation and no flow exiting through the over-pressure valve, contact your authorized distributor for service and troubleshooting

4.2. Cleaning the Device

The Nitronox Scavenger Plus must be cleaned between each use in order to prevent the spread of infections. Cleaning of the device should be conducted with Super Sani-Cloth™ Germicidal or similar wipes.

WARNING: The following warning applies to the device and any device components and accessories:



- Do not spray directly with disinfecting chemicals.
- Do not immerse in water, sanitizer, cleaning solution, or any other liquid.
- Do not sanitize or wipe the inside of the fittings, gas supply hoses, or connection ports.
- Always ensure the device and device's components and accessories are completely dry before use.

Cleaning Instructions









1	Disconnect and dispose of the single use breathing circuit and single use mask/mouthpiece (if attached). The reservoir bag and vacuum hosing may be disconnected and wiped down.
2	Using a Super Sani-Cloth™ Germicidal wipe, thoroughly wipe down the outer case, front panel, and back of the device until all visible dirt and soil is removed. Take extra care to wipe the outside of the connection port area and vacuum control knob area as these are the most handled areas of the device. The under and over pressure valve areas should not be exposed to the cleaners or wiped to prevent moisture from entering the device. A soft bristled brush may be used to loosen any soil that is difficult to remove. Avoid wiping and applying cleaner to the inside of the over pressure valve and under pressure valve.
3	Perform the setup and pre-use checks as specified in Section 3.1.



4.3. Disposal

It is best practice to inquire with local authorities for proper disposal guidelines, if applicable.

5. Symbols Glossary

The following symbols are used throughout this document, as well as on device labels and packaging.

Symbol	Title of Symbol	Description of Symbol
	Manufacturer Information	Indicates the medical device manufacturer and is accompanied by the name and address of the manufacturer. [EN ISO 15223-1:2021, clause 5.1.1]
	Date of manufacture and Country of manufacture	Indicates the country where the device was manufactured. Also Indicates the date when the device was manufactured. This symbol is accompanied by four digits for the year the device was manufactured. [EN ISO 15223-1:2021, clause 5.1.3, 5.1.11]
	Catalogue Number	Indicates the manufacturer's catalogue number of the device and is used for identification of the device. [EN ISO 15223-1:2021, clause 5.1.6]
	Serial Number	Indicates the manufacturer's serial number of the device and is used for identification of the specific device. [EN ISO 15223-1:2021, clause 5.1.7]
	Unique device identifier	Indicates a carrier that contains unique device identifier information [EN ISO 15223-1:2021, clause 5.7.10]
	Prescription device	Indicates that federal law restricts this device to sale by or on the order of a physician or dentist.
	Medical Device	Indicates the item is a medical device [EN ISO 15223-1:2021, clause 5.7.7]
	Consult Instructions for Use	Indicates the need for the user to consult the instructions for use [EN ISO 15223-1:2021, clause 5.4.3]
	Caution	Indicates the need for the user to consult the instructions for use for important cautionary information such as warnings and precautions that cannot be presented on the medical device itself. [EN ISO 15223-1:2021, clause 5.4.4]

Symbol	Title of Symbol	Description of Symbol
	Caution/Warning	<p>Indicates important cautionary or warning information to the user that is presented in the instructions for use that accompanies explanatory instructions to the user</p> <p>[EN ISO 15223-1:2021, clause 5.4.4]</p>
	MR Unsafe	<p>Indicates that the product should not be used near any magnetic resonance equipment</p> <p>[ASTM F2503-20 Table 1 and Table 2]</p>

6. Warranty

CERTIFICATE OF WARRANTY

THIS WARRANTY IS GIVEN IN PLACE OF ALL OTHER WARRANTIES, EXPRESS OR IMPLIED, OF MERCHANTABILITY, FITNESS FOR A PARTICULAR PURPOSE OR OTHERWISE.

Under no circumstances shall Parker Hannifin Corporation be liable for incidental or consequential damages as those terms are defined in the uniform commercial code.

Parker Hannifin Corporation, Porter Instrument warrants that each product or part shall be free from defects in workmanship and materials, under normal use and with appropriate maintenance, for one (1) year from the date of delivery to customer unless otherwise specified in writing. All rubber and plastic parts and accessories are warranted under the same conditions for a period of ninety (90) days from date of purchase.

No statement or claim about the product by any employee, agent, representative, or dealer of Parker Hannifin Corporation shall constitute a warranty by Parker Hannifin Corporation or give to rise to any liability or obligation of Parker Hannifin Corporation.

Parker Hannifin Corporation shall not be liable for any damage, injury or loss arising out of the use of the product, whether as a result of a defect in the product or otherwise, if, prior to such damage, injury or loss, the product was (1) damaged or misused; (2) repaired, altered or modified by persons other than Parker Hannifin Corporation; (3) not installed in strict compliance with applicable codes and ordinances; or (4) not installed by an authorized Parker Hannifin Corporation dealer. Parker Hannifin Corporation's obligation for breach of this warranty, or for negligence or otherwise, shall be strictly and exclusively limited to the repair or replacement of the product or part. This warranty shall be void on any product on which the serial number has been altered, defaced or removed.

ORDERS All orders are to be made through authorized Parker Hannifin Corporation distributors. All billing will be done through said distributors. Direct orders will be handled through the authorized local dealer as determined by Parker Hannifin Corporation.

RETURNS All returned merchandise will be handled through the local Parker Hannifin Corporation distributor. No returns will be accepted unless authorized in writing by Parker Hannifin Corporation and accompanied by the original shipping invoice. All returns are subject to restocking charge.

Policies subject to change without notice.

To register your product: www.porterinstrument.com/medical-support and click on Warranty Registration Form button.